



## FIRE PROTECTION WITHOUT COMPROMISE.

ALPOLIC™ fire protection performance



# SAFELY HIGH UP – WITH ALPOLIC™

## Content overview

**The trend is towards denser building, especially in cities and conurbations. High-rise construction in particular continues to expand.** As building heights increase, so do the requirements for safety and structural fire protection. Especially in recent years, this has repeatedly come to the fore of discussions due to numerous tragic fire incidents. As a result, high-rise buildings in many European countries have been reassessed in terms of their fire risk and building regulations have been updated and tightened. Particular attention is paid to façade cladding – because, as an essential component of the building envelope, this is repeatedly identified as a potential “fire accelerant”.

### Fire protection in line with requirements has top priority

Since architects and planners bear a significant responsibility in the planning and execution of fire protection measures required by law and building regulations, the choice of a suitable façade material is of paramount importance. Not least in high-rise and high-risk buildings. These are buildings where the effects of a fire can be devastating – for example, schools, hospitals, hotels or retirement homes. Only non-combustible building materials may be used here.

### Future building use

Future building use must also be taken into account: A building that is not considered a high-risk building today could become one in a few years as a result of a change in use – for example, from an office complex to a retirement home. From a fire protection point of view it is therefore advisable to consider the safety of a building and its occupants over its entire service life. The use of non-combustible building materials is the only way to minimise the hazard potential of current and future high-risk buildings.

### Trendsetting façade solutions for the rear ventilated façade

And that is where ALPOLIC™ comes in: as a leading supplier of high-quality aluminium composite panels (ACM) for use on ventilated façades, we have been developing forward-looking solutions for many years that meet all fire protection requirements, increase the safety of buildings and thus enable the protection of health and human life.

**Fire protection without compromise – that's ALPOLIC™.**

About ALPOLIC™ / 04

Rear-ventilated façade system / 06

Euroclasses and test methods / 08

Large-scale fire tests / 10

Fire protection regulations in Germany, France and Great Britain / 11

ALPOLIC™ aluminium composite panels / 16

ALPOLIC™: International fire classifications / 18

Summary / Recommendations / 19

**BE.SAFE.** SAFETY IS OUR MISSION



**Innovations for future-oriented construction**

Mitsubishi Chemical is a global market leader known for its superior product quality and performance. The entire process of corporate activity is carried out in accordance with the KAITEKI principle. It serves as a guideline and combines ecological, economic and social sustainability with the pursuit of safety, health and a better quality of life.

ALPOLIC™ – a brand of Mitsubishi Chemical Group – has been producing aluminium composite panels (ACM) for the complete range of building architecture in new and existing buildings for more than 50 years. With numerous innovations, we have significantly influenced the trends in the market and set new standards.

In 2010, we made a decisive step with the market launch of ALPOLIC™ A2 by introducing a composite material with the classification A2-s1, d0. We then continued to develop it further and launched ALPOLIC™ NC/A1 in 2021, a composite panel with 100% non-combustible core and the fire protection classification A1 in accordance with EN 13501-1.

**World market leader for aluminium composite panels**

With a global production volume of 10–12 million m<sup>2</sup>, we are the world market leader in our industry and have manufacturing facilities in Japan, the USA, and also in Germany. In our plant in Wiesbaden (production capacity 1.5 million m<sup>2</sup>), our aluminium composite panels are quality-manufactured under the strictest safety and environmental requirements.

**Pioneer in fire protection**

BE.SAFE: That is our claim and our motivation. We do everything we can to offer our customers safe products. As a pioneer, we continuously invest in research and development, particularly in the area

of fire protection. Our commitment is also strengthened by our headquarters in Japan.

**Manufacturer of ACM in A1**

We are a manufacturer of aluminium composite panels with fire classification A1 according to EN 13501-1. In addition, we maintain a continuous dialogue with national authorities in order to constantly develop our products in accordance with the latest safety standards. Our primary goal remains to offer our customers the highest level of safety.

**Continuous reduction of combustible materials in the panel core**

In Europe, no more architectural applications were clad with aluminium composite panels (ACM) from ALPOLIC™ containing a polyethylene (PE) core after 1998. These combustible materials in the core exhibit poor fire behaviour and therefore represent a high safety risk. Since 1999, we have only manufactured composite panels that are either flame-retardant (B-s1, d0) or have a non-combustible A1 core or EN13501-1 (A2-s1, d0). Safety is our top priority - compromises are not an option for us.

**Large fire tests**

In view of the tragic fire disasters of recent years, we have carried out intensive research work and had the fire behaviour of our aluminum composite panels tested in extensive large-scale fire tests by independent institutes and in our own tests. This means we have comprehensive know-how and current data that are not available in this form for other façade materials.



<b>Some milestones of our innovative strength</b>	<b>1971</b>	Start of pilot production of ALPOLIC™ in Japan	<b>1998</b>	Introduction of ALPOLIC™/fr (flame retardant)	<b>2010</b>	Introduction of ALPOLIC™ A2 (EN 13501-1, class A2-s1, d0)	<b>2020</b>	Introduction of ALPOLIC™ NC/A1 (non-combustible); Composite material classified according to fire protection class "Euroclass A"
---	-------------	--	-------------	---	-------------	---	-------------	--









## NON-COMBUSTIBLE VENTILATED FAÇADE: IT'S THE OVERALL SYSTEM THAT COUNTS.

The construction principle of the rear-ventilated façade has proven itself for many years and offers many advantages in terms of building physics and appearance. It is considered safe in terms of fire protection – provided that it is planned and executed properly. However, the current legal fire protection regulations must be taken into account when selecting materials and combining façade components. The individual components of the rear-ventilated façade are described in the German DIN 18516-1.

### Cladding material – a wide range of possibilities:

- Aluminium composite panels (ACM)
- Ceramics
- Glass
- Natural stone
- Wood
- Fibre cement
- HPL panels (High Pressure Laminate)
- Metal
- Stone wool

### The advantages of the rear-ventilated façade at a glance

-  Protection against condensation and mould ("rear ventilation")
-  Healthy and pleasant indoor climate
-  Cold protection in winter
-  Heat protection in summer ("heat shield")
-  Soundproofing effect
-  Protection of the load-bearing wall against impacts and weather influences
-  Humidity protection due to permanent air flow
-  Easy dismantling and recycling due to separability of components
-  Easy access for maintenance or renovation work

### What is a fire barrier?

A fire barrier impedes fire spread in the rear-ventilation space for a sufficiently long time. Its function is characterised by an interruption or partial reduction of the free cross-section in the rear ventilation space of the rear-ventilated façade. Where proof is required, the fire barrier must remain sufficiently dimensionally stable for a period of 30 minutes.

### The components of the rear-ventilated façade at a glance.

- 1 Façade cladding**  
This is crucial for the longevity of the façade – so the materials used must meet criteria such as durability, UV, weather and frost resistance.
- 2 Substructure**  
This forms the static link between the load-bearing exterior wall and the façade cladding. For example, it consists of supporting and, if necessary, wall profiles made of metal or wooden slats.
- 3 Anchoring, connecting and fastening elements**  
These connect the various components and ensure a firm hold of the construction.
- 4 Ventilation space**  
This air space regulates the moisture balance in the building structure. Building and occupancy moisture is reliably removed by the air flow.
- 5 Insulation**  
The use of mineral insulating materials is common here.

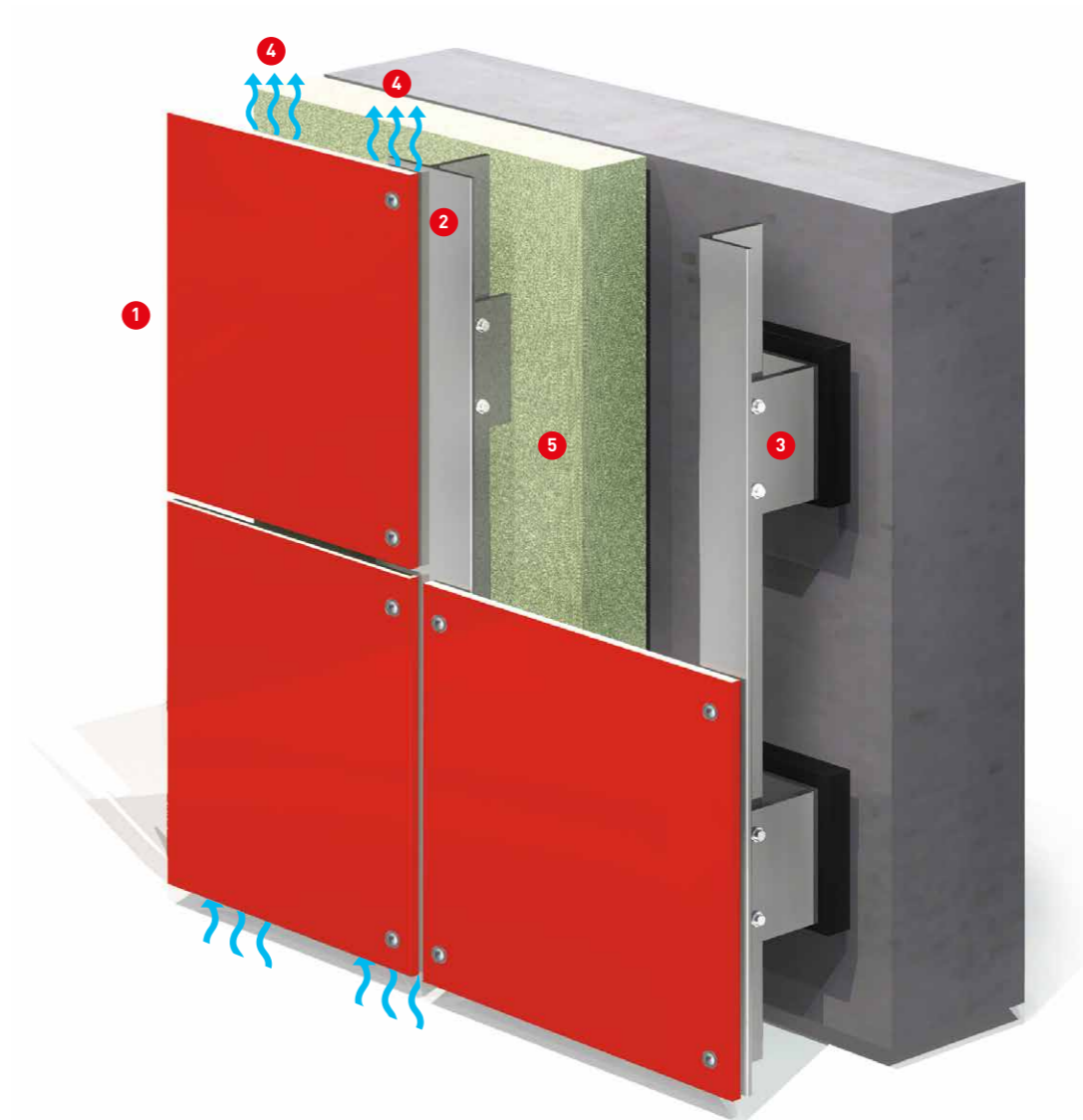

Detailed requirements and information for the planning of safe fire protection for rear-ventilated façades can be found on the website of the German "Fachverband Baustoffe und Bauteile für vorgehängte hinterlüftete Fassaden e.V. (FVHF)" at [www.fvhf.de](http://www.fvhf.de)

## THE EUROCLASSES: STANDARDISED FIRE PROTECTION IN EUROPE

### Classification for better comparability

With the EN 13501-1 series of standards, a uniform European classification system for the fire behaviour of building materials was adopted in 2001 to enable cross-national comparability of the fire protection properties of building products. In addition to the fire behaviour, the smoke behaviour is also considered. The possible formation of burning droplets is also taken into account. Ultimately, the respective fire protection class ("Euroclass") is decisive for assessing the suitability of a material for a building project.

### What distinguishes the seven Euroclasses?

The building materials are classified in terms of their combustibility and flammability in the seven **Euroclasses A1, A2, B, C, D, E and F** – in ascending order from F to A1. With each class, the requirements and the scope of the tests increase. In the lowest class F there are no tests. In Class E, the test is carried out with a small flame over a relatively short period of time. The SBI test ("Single Burning Item", see next page) is the guideline for the determination of Euroclasses B to D. From Euroclass D onwards more, more detailed tests are already carried out and smoke development (s) and burning dripping (d) are also taken into account.

**Euroclass A1** and **A2** building materials are defined to conform to EN13501-1. A1 non-combustible in the UK and additionally A2-s1-do as non-combustible for the wider European market. This means that they do not represent a fire hazard or fire load, but are passively involved in the event of a fire. For both Euroclass A1 and A2, in addition to all the tests for the classification levels below, the calorific value test is also included.

### What is the difference between EN 13501 and the national DIN 4102?

The classifications according to DIN 4102 and EN 13501 are not directly transferable to each other. However, according to the Building Rules List A of DIN 4102 (Annex 0.2.2), both European and national designations can be assigned to the building authority designations (non-combustible, flame-retardant, normally flammable and readily flammable).

### What do the additions s1, s2 and s3 mean?

Smoke production is tested in the SBI test and refers to the amount of smoke produced by the product during a fire. The indication is given with the letter "s" (smoke) – divided into three levels:

- "s1": low smoke production,
- "s2": moderate smoke production,
- "s3": strong smoke production, or a test that has not been carried out.

Exclusively for A1-classified building materials, **no smoke** is certified.

### What do the additions d0, d1 and d2 mean?

The addition with the letter "d" (= droplets) defines the flaming droplets/particles within the first ten minutes of the fire:

- "d0": no droplets/particles off
- "d1": limited droplets/particles off
- "d2": heavy droplets/particles off

## SAFE IS SAFE: FIRE TEST METHODS AT A GLANCE

The fire behaviour of building materials is determined according to specified parameters within the framework of various tests and classified according to EN 13501-1. The following main properties are investigated: flammability, smoke production, flaming droplets. The classification provides information on the contribution a material can make to fire initiation and development. This, in turn, is an important criterion in the selection of materials and evaluation of the fire safety of a façade. The limit values of the Euroclasses are essentially based on SBI tests (test of a single burning object) or the more extensive "room-corner tests" (ISO 9705). Based on the results, the tested building materials are classified into the corresponding Euroclasses. The boundaries between the individual classes are defined in each case by the time span until the "flashover".

### SBI-Test ("Single Burning Item")

The SBI test is used **to assess the fire behaviour of a building material** and simulates the onset of a fire. The classification (Euroclass) is based on the various parameters tested – for example, flame spread, flammability, amount of heat, smoke and toxic gases. In addition, whether a product melts, drips or chars is also taken into account.

### Flammability test (EN ISO 11925-2)

This very simple test setup uses a small flame to determine whether a product can ignite easily and whether the fire expands quickly. This method is used for the classification of classes B, C, D and E.

### Non-combustibility test (EN ISO 1182)

This test is used to identify A1- and A2-classified products – i.e. those that **do not contribute or do not contribute significantly to a fire**. In the process, a material sample is placed in an oven heated to approx. 750 °C for a maximum of 60 minutes. Depending on the temperature change, mass loss and duration of sustained ignition, the classification is made.

### Calorific potential test (EN ISO 1716)

This **specific calorific potential test** determines the potential maximum total heat release of a product during complete combustion. In the process, a powdered test specimen is ignited under pressurised oxygen in a closed steel cylinder surrounded by water. To determine the calorific value potential (PCS), the temperature rise of the water is measured. If the value remains below max. 2 MJ/kg, the material is classified as A1.

### Comparison of the building authority designations of building materials to the European classifications according to EN 13501-1 and the classifications of the German DIN 4102-1.

Building inspection requirement	European building material class according to EN 13501-1	German building material class according to DIN 4102-1	Additional requirements	
			Smoke development (s = smoke)	Burning Dripping (d = droplets)
Non combustible	A1	A1	none	none
	A2-s1, d0	A2	low	none
Flame retardant	B-s1, d0 or C-s1, d0	B1	low	none
	A2-s2, d0 or A2-s3, d0		moderate/strong	none
	B-s2, d0 or B-s3, d0		moderate/strong	none
	C-s2, d0 or C-s3, d0		moderate/strong	none
	A2-s1, d1 or A2-s1, d2		low	strong
	B-s1, d1 or B-s1, d2		low	strong
	C-s1, d1 or C-s1, d2		low	strong
	A2-s3, d2		strong	strong
	B-s3, d2		strong	strong
Normal flammability	D-s1, d0 or D-s2, d0	B2	low/moderate	none
	D-s3, d0 or E		strong	none
	D-s1, d1 or D-s1, d1		low	confined
	D-s3, d1 or D-s1, d2		strong/low	confined/strong
	D-s2, d2 or D-s3, d2		moderate/strong	strong
	E-d2			strong
inflammable	F	B3		

#### Fire classifications:

**A:** Non-combustible, no contribution to fire

**B:** Flame retardant, very limited contribution to fire

**C:** Flame resistant, limited contribution to fire

**D:** Normal flammability, acceptable contribution to fire

**E:** Normal flammability, acceptable fire behaviour

**F:** Highly flammable, no performance determined.



An overview of all relevant German regulations for testing of the reaction to fire of building products can be found at: [www.baunetzwissen.de/brandschutz/fachwissen/baustoffe-bauteile/brandverhalten-baustoffe-nach-deutscher-klassifizierung-3112695](http://www.baunetzwissen.de/brandschutz/fachwissen/baustoffe-bauteile/brandverhalten-baustoffe-nach-deutscher-klassifizierung-3112695)

## ON THE SAFE SIDE COUNTRY-SPECIFIC LARGE-SCALE FIRE TEST

In order to evaluate the fire behaviour of façade constructions under real fire loads, individual standards for large-scale façade fire tests have been defined in different countries. Large-scale fire test simulate the behaviour of façade constructions under fire exposure. However, these tests have their limitations, as they only simulate a simplification of the real façade structure and the results also strongly depend on the design structure.

The large-scale fire tests are subject to country-specific regulations and differ in terms of test set-up, fire loads and evaluation criteria. EU harmonisation is expected in the next few years. Here is an overview of the best-known international test methods for façade systems:

Country	Assessment method
Austria	ÖNORM B 3800-5
Czech Republic	ČSN ISO 13785-1
Denmark, Sweden, Norway	SP Fire 105
Finland	SP Fire 105 BS 8414
France	LEPIR 2
Germany	DIN 4102-20 Complementary reaction-to-fire test for claddings of exterior walls, Technical regulation A 2.2.1.5
Hungary	MSZ 14800-6:2009 Fire resistance tests. Part 6: Fire propagation test for building facades
Ireland	BS 8414 (BR 135)
Poland	PN-B-02867:2013
Slovenia	ISO 13785-2
Switzerland, Liechtenstein	DIN 4102-20 ÖNORM B 3800-5 Test specification for external wall cladding systems
UK	BS 8414-1:2015 and BS 8414-2:2015

## FIRE PROTECTION REGULATIONS IN GERMANY: OVERVIEW OF COUNTRY-SPECIFIC REGULATIONS

Depending on the federal state and market, specific and sometimes very different fire protection regulations must be taken into account in the planning process for high-rise structures and other buildings.

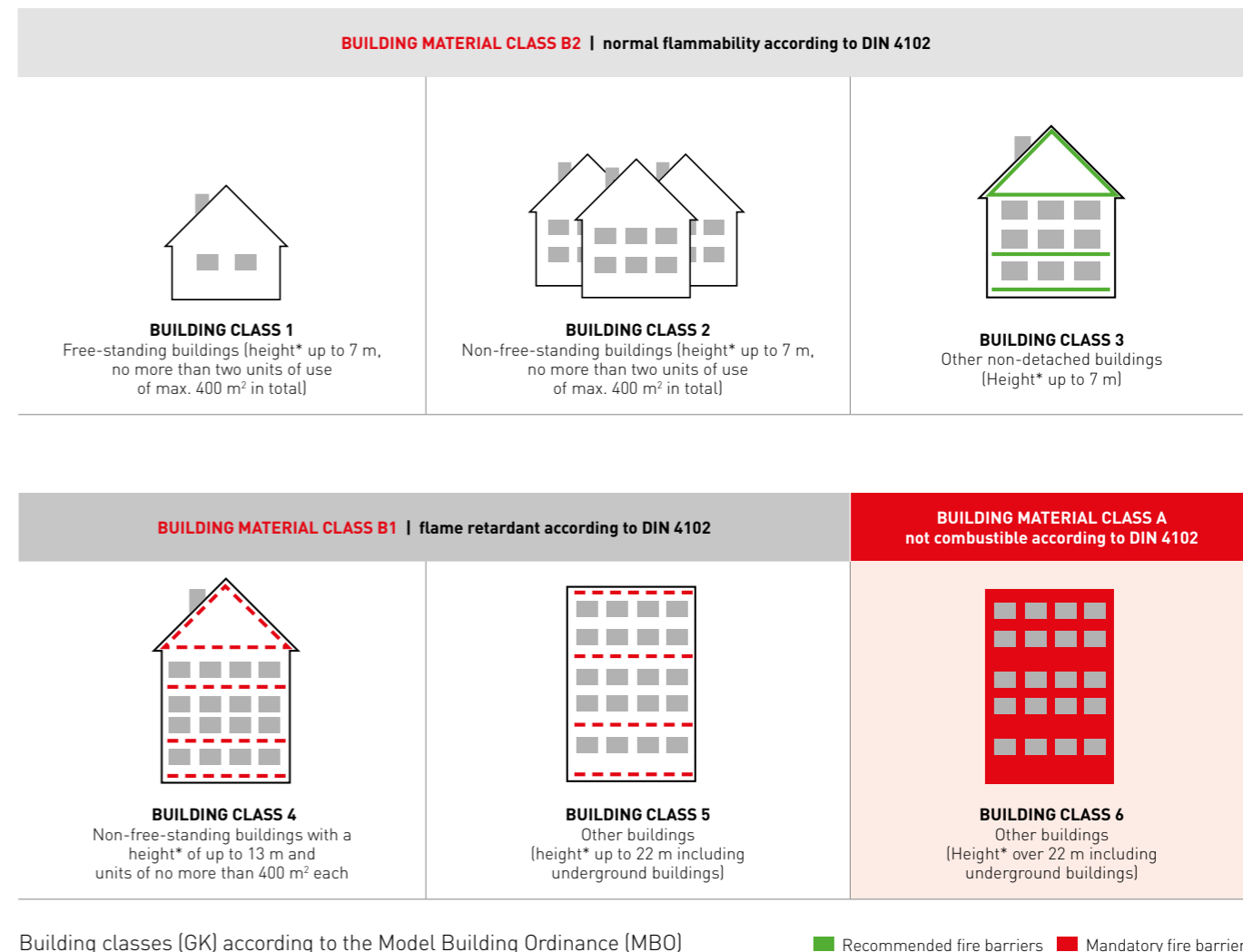

Building classes (GK) according to the Model Building Ordinance (MBO)

\* The upper edge of the ground to the finished floor of the top storey applies in this case.



All relevant information, download possibility of the building codes of the respective German federal states as well as the model guideline on the construction and operation of high-rise buildings can be found at [www.bauordnungen.de](http://www.bauordnungen.de)

## FR FIRE PROTECTION REGULATIONS IN FRANCE: COUNTRY-SPECIFIC REGULATIONS AT A GLANCE

		Regulation	Height	Reaction to fire	Airflow fire barrier	Rule of C+D
Residential buildings	1st family	Decree of 31/01/86 modified by the order of 07/08/2019	$h \leq 7\text{ m}$ R+1	D-s3, d0 or wood	No requirement	No requirement
	2nd family		$h \leq 13\text{ m}$ R+2 à R+3	D-s3, d0		
	3rd family		$13\text{ m} < h \leq 28\text{ m}$ R+4 à R+9	A2-s3, d0 with laboratory of laboratory LEPiR 2 for aluminium composites (possibility of validate a lower class)	According to laboratory assessment/LEPIR 2  or According to IT 249 with visible fire barrier (steel plate)  Aluminium composites must have an APL	<b>3rd family A</b> if $C+D \geq 0,6\text{ m}$ , $M \leq 80\text{ MJ/m}^2$ if $C+D \geq 1\text{ m}$ , $80 < M \leq 130\text{ MJ/m}^2$ if $C+D \geq 1,3\text{ m}$ , $M > 130\text{ MJ/m}^2$
	4th family (IMH)		IMH $28\text{ m} < h \leq 50\text{ m}$ R+10 à R+16	A2-s3, d0 with laboratory assessment LEPiR 2 for aluminium composites		<b>3rd family B</b> if $C+D \geq 0,8\text{ m}$ , $M \leq 80\text{ MJ/m}^2$ if $C+D \geq 1\text{ m}$ , $80 < M \leq 130\text{ MJ/m}^2$ if $C+D \geq 1,3\text{ m}$ , $M > 130\text{ MJ/m}^2$  <b>4th family</b> if $C+D \geq 0,8\text{ m}$ , $M \leq 80\text{ MJ/m}^2$ if $C+D \geq 1\text{ m}$ , $80 < M \leq 130\text{ MJ/m}^2$ if $C+D \geq 1,3\text{ m}$ , $M > 130\text{ MJ/m}^2$
ERP	$h \leq 50\text{ m}$	IT 249, decree of 24/05/2010	if C+D not applied	C-s3, d0	Glass façade with horizontal cassette: Flame-resistant 1 hour  Rainscreen façade: firestop every 2 floors	No requirement
			if C+D applied	D-s3,d0 or wood		<b>ERP <math>\leq 50\text{ m}</math></b> if $C+D \geq 1\text{ m}$ , $M \leq 130\text{ MJ/m}^2$ if $C+D \geq 1,3\text{ m}$ , $M > 130\text{ MJ/m}^2$
IGH/ITGH	$h > 50\text{ m}$	Decree of 30/12/2011	$IGH > 50\text{ m}$	A2-s3, d0 with laboratory assessment LEPiR 2 for aluminium composites	Obtaining a "façade approval". Case by case study, based on the results of the LEPiR 2 and APL tests.	<b>Glass façades <math>&gt; 50\text{ m}</math></b> if $C+D \geq 1,2\text{ m}$ , $M \leq 80\text{ MJ/m}^2$ if $C+D \geq 1,5\text{ m}$ , $M > 130\text{ MJ/m}^2$ or EI60 Unglazed façades $> 50\text{ m}$ : EI60
			ITGH $> 200\text{ m}$			
Industrial buildings		Labour Code, article R. 235-4		No requirement	No requirement	No requirement

## GB FIRE PROTECTION REGULATIONS IN GREAT BRITAIN: COUNTRY-SPECIFIC REGULATIONS AT A GLANCE

### Building categories

Fire protection design requirements are determined by the use in relation to the building type. At the beginning of a construction project and in the planning phase the designer determines the operational and building services class that the building must meet.

- Residential: Approved Document B (fire safety) volume 1: Dwellings, 2019 edition
- Other buildings: Approved Document B (fire safety) volume 2: Buildings other than dwellings, 2019 edition

Building type	Building height	Less than 1,000 mm from the relevant boundary	1,000 mm or more from the relevant boundary
'Relevant buildings' as defined in regulation 7(4) (see paragraph 12.11)		Class A2-s1, d0 <sup>(1)</sup> or better	Class A2-s1, d0 <sup>(1)</sup> or better
Assembly and recreation	More than 18 m	Class B-s3, d2 <sup>(2)</sup> or better	From ground level to 18 m: class C-s3, d2 <sup>(3)</sup> or better From 18 m in height and above: class B-s3, d2 <sup>(2)</sup> or better
	18 m or less	Class B-s3, d2 <sup>(2)</sup> or better	Up to 10 m above ground level: class C-s3, d2 <sup>(3)</sup> or better Up to 10 m above a roof or any part of the building to which the public have access: class C-s3, d2 <sup>(3)</sup> or better <sup>(4)</sup> From 10 m in height and above: no minimum performance
Any other building	More than 18 m	Class B-s3, d2 <sup>(2)</sup> or better	From ground level to 18 m: class C-s3, d2 <sup>(3)</sup> or better From 18 m in height and above: class B-s3, d2 <sup>(2)</sup> or better
	18 m or less	Class B-s3, d2 <sup>(2)</sup> or better	No provisions

### NOTES:

In addition to the requirements within this table, buildings with a top occupied storey above 18 m should also meet the provisions of paragraph 12.6.

In all cases, the advice in paragraph 12.4 should be followed.

1. The restrictions for these buildings apply to all the materials used in the external wall and specified attachments (see paragraphs 12.10 to 12.13 for further guidance).
2. Profiles or flat steel at least 0.5 mm thick with an organic coating of no more than 0.2 mm thickness is also acceptable.
3. Timber cladding at least 9mm thick is also acceptable
4. 10 m is measured from the top surface of the roof.

**Note:** fire classes according to BS EN 13501-1.

## FIRE BEHAVIOUR OF FAÇADE PANELS: THE CALORIFIC VALUE IS DECISIVE

### What actually is the calorific value?

As an important indicator, the calorific value describes the amount of energy that is generated during the complete combustion of a material – for example, a façade panel. The calorific value is indicated by the PCS value (“Pouvoir Calorifique Supérieur”).

The rule is: the lower the PCS value, the lower the contribution to a fire. Non-combustible façade materials (A1 and A2 classified) have a very low calorific value and thus contribute very little to a fire.

### The overall system determines the fire behaviour

The fire behaviour of the façade refers not only to the cladding, but to the entire façade system, including the insulation.

Example:

Using ALPOLIC™ NC/A1 in combination with stone wool insulation results in a total calorific value of 15 MJ/m² (8 MJ/m² for the board and 7 MJ/m² for the stone wool insulation). This is currently one of the best calorific values on the market, with a lower percentage of fire residues at the same time.

### Comparison of PCS values of different façade claddings

The overview shows the calorific values of different façade materials, all measured with identical test methods. And you can see immediately that ALPOLIC™ NC/A1 has by far the lowest calorific value.

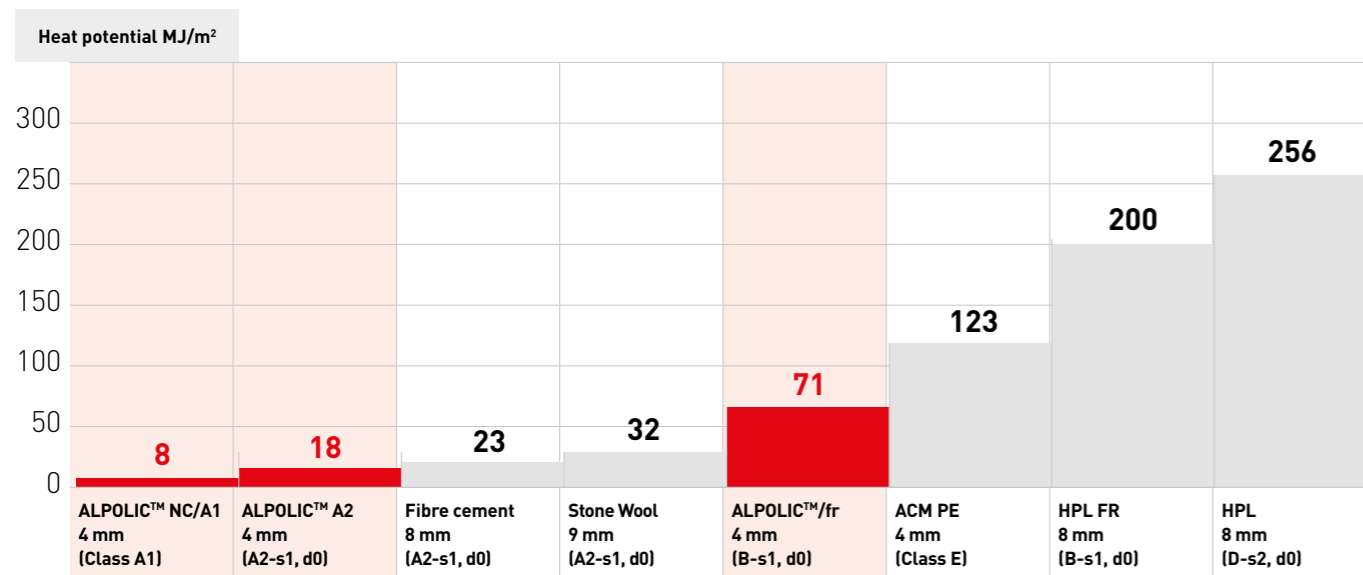

## DEBRIS: A RISK THAT SHOULD NOT BE UNDERESTIMATED

If a fire breaks out in a building despite all precautionary measures, the fire residues of the material used are also a fundamental factor. Specifically, this involves the question of the extent to which burning falling parts affect the evacuation of people present in the building. In particular, the weight of the falling material plays a decisive role for safety.

Every gram counts here. Against this background, the ALPOLIC™ composite material was compared with 3 mm solid aluminium in extensive and certified tests. The result clearly shows that the debris with composite material is considerably lower and also much lighter than with comparable façade cladding made of solid metal. A factor that can protect human lives.

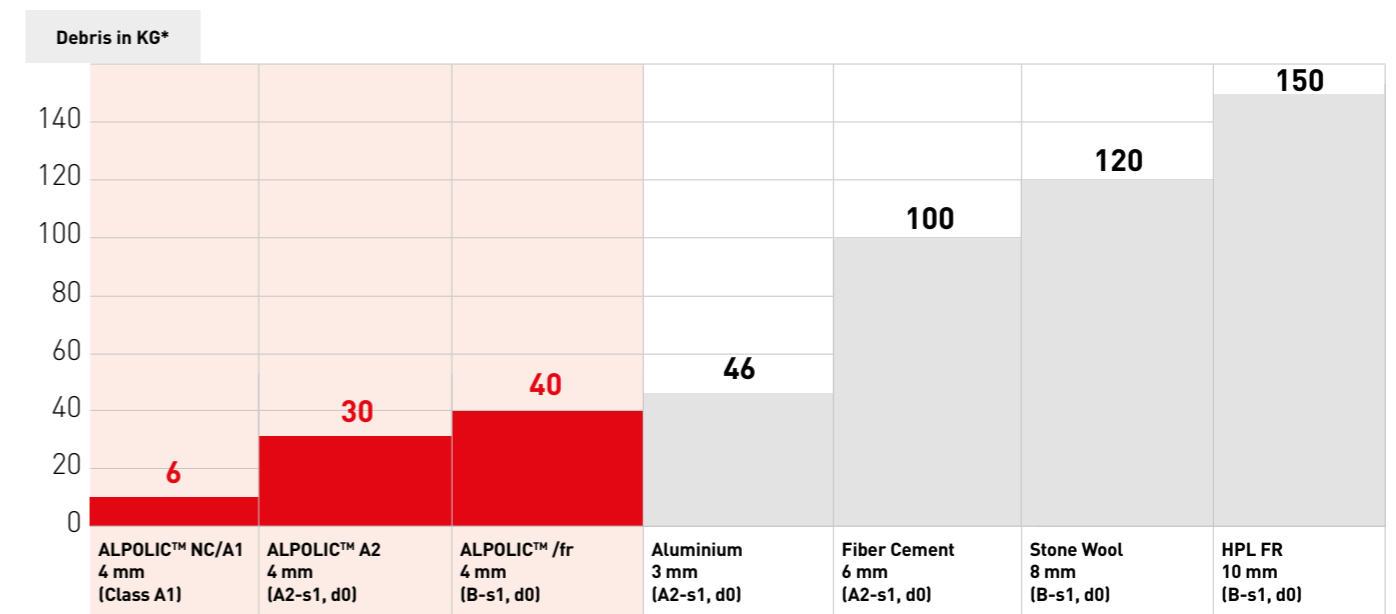

\*Comparison of debris quantity in KG during BS8414 large scale fire tests with different cladding materials.

### Comparison of aluminium composite panels to 3 mm solid aluminium

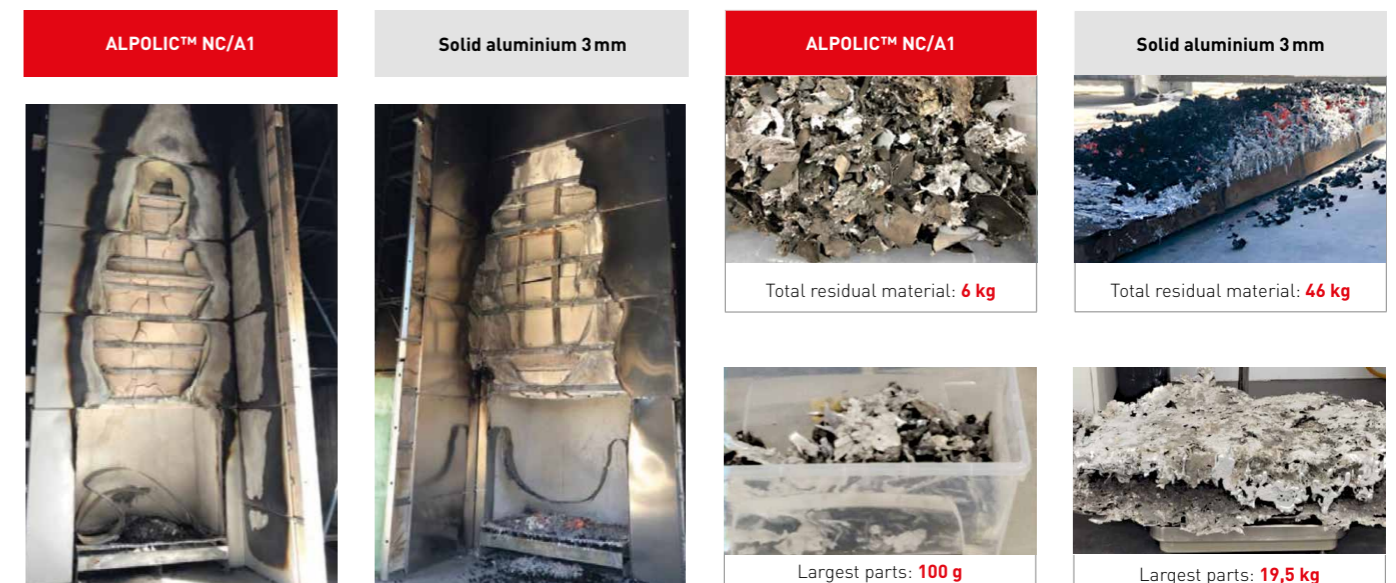

Result after a large-scale fire test (BS8414-2)

Debris of A1

Debris of solid aluminium

## ALPOLIC™: SAFE FAÇADE SOLUTIONS FOR EVERY REQUIREMENT

Excellent product quality – that is what you can expect from ALPOLIC™ aluminium composite panels. Our range offers a fire-safe solution for every façade requirement in new constructions and renovations. All our products have been extensively tested in large-scale fire tests by independent institutes as well as in our own tests.

### Highest quality due to special manufacturing process

The high quality of ALPOLIC™ aluminium composite panels results from a special manufacturing process. The sheets consist of two 0.5 mm thick aluminium cover sheets. Depending on the product, these are applied to a flame-retardant or non-combustible mineral core in a fusing process. The composite panels are manufactured using a coil coating process with the latest coil coating technology.



### High-quality surface coating for brilliant colors

The front is coated with LUMIFLON™ or with High Durable Polymer (HDP). Both coatings guarantee high colour stability, provide reliable protection against weathering, UV radiation, corrosion and acids and are efficiently resistant to chalking. The coating is guaranteed for up to 20 years. LUMIFLON™ is a coating, based on a transparent fluoropolymer resin (FEVE). The reverse side of the composite panels is coated with a polyester-based coating to protect against corrosion.

You can find out more about ALPOLIC™ Performance Power in our video:



### ALPOLIC™ Composite panels: Core material calorific values in comparison

	ALPOLIC™/fr	ALPOLIC™ A2	ALPOLIC™ NC/A1
Proportion of combustible ingredients in the core material	≤ 30 % 	≤ 10 % 	≤ 5 % 
Thermal potential of the core material	≤ 15 MJ/kg	≤ 3 MJ/kg	≤ 1 MJ/kg

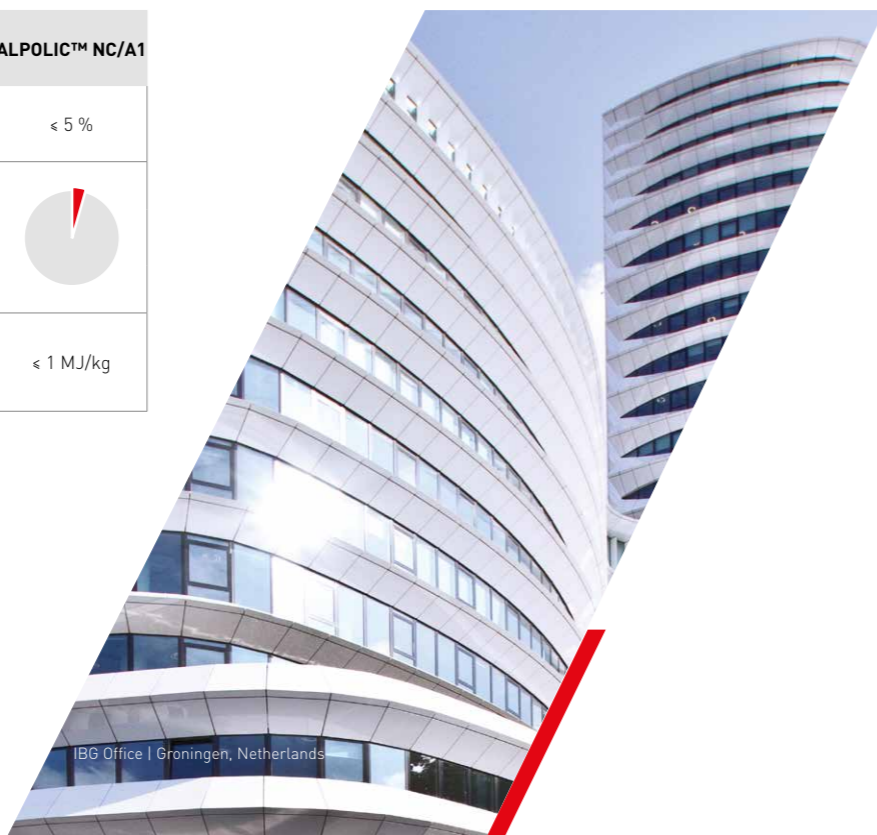

## ALPOLIC™ – PRODUCT VARIANTS IN DETAIL

### ALPOLIC™ NC/A1

The ALPOLIC™ NC/A1 composite panel is an aluminium composite material classified for Euroclass A1 according to EN 13501-1.

#### This means:

As a non-combustible aluminium composite panel with A1 classification according to EN 13501-1, ALPOLIC™ NC/A1 is particularly suitable for areas where very high fire protection or the use of non-combustible façade materials is required – for example, high-rise buildings, high-risk buildings, stairwells and the like.

### Maximum fire protection

Non-combustible and no smoke development in case of fire.

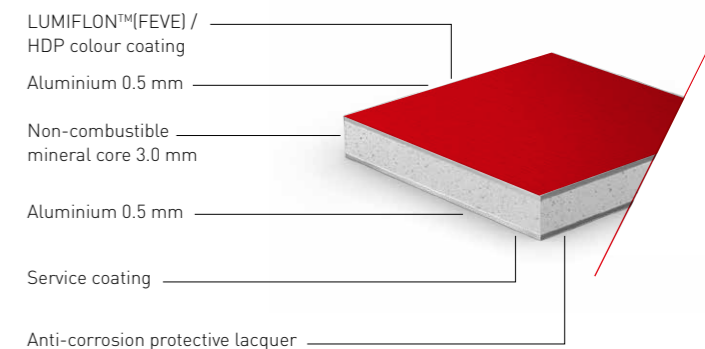

### ALPOLIC™ A2

The ALPOLIC™ A2 composite panel meets the high fire protection requirements of EN 13501-1, class A2-s1, d0.

#### This means:

ALPOLIC™ A2 aluminium composite panels are the ideal material for cladding high-rise and high-risk buildings, where the use of Euroclass A2 façade materials is mandatory.

### (A2) Conforms to the fire protection requirements tested to EN 13501-1, class A2 - s1, d0

Low smoke emission in case of fire.

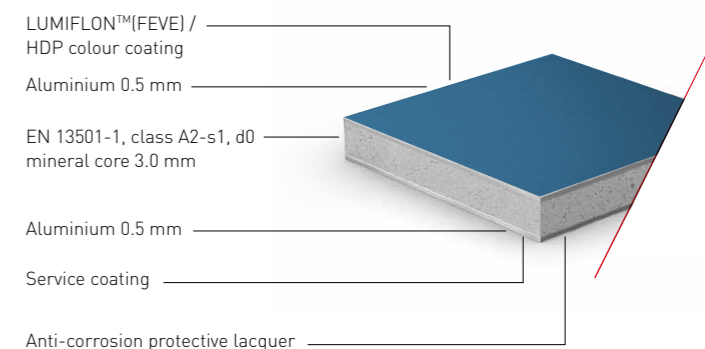

### ALPOLIC™/fr

The ALPOLIC™/fr aluminium composite panel meets the fire protection requirements of EN 13501-1 of fire class B-s1, d0.

#### This means:

ALPOLIC™/fr aluminium composite panels are ideally suited for the sophisticated design of rear-ventilated building façades, cladding of façades and roof structures and for interior applications. Both in existing and new buildings.

### The flame retardant standard

Flame retardant and medium smoke emission in case of fire.

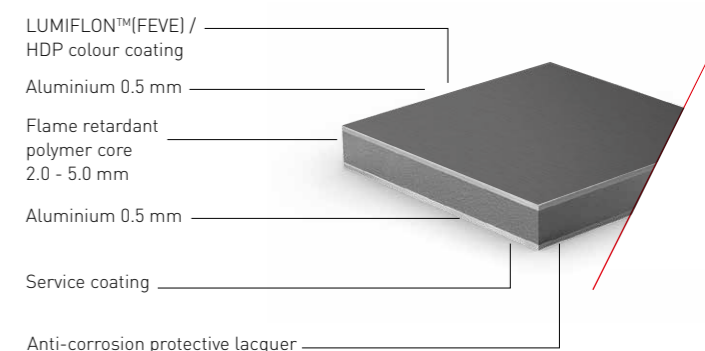

## ALPOLIC™ NC/A1

Country	Examination according to ...	Result & Classification	Comment
EU	EN 13501-1 (Subsequent tests as required)	Class A1	
	EN ISO 1182	Passed	Core test
	EN ISO 1716	Passed	Heat potential value
	EN 13823	Passed	Plate test
Australia	AS 1530.1	Classified as non-combustible	Core test
	AS 1530.3	Flammability index 0, Flame spread index 0, Heat development index 0, Smoke emission index 0	Plate test
Singapore	BS 476 part 4	Passed	Core test

## ALPOLIC™ A2

Country	Examination according to ...	Result & Classification
EU (applicable in Europe, Switzerland and Turkey)	EN 13823, EN ISO 1716, EN 13501-1	Class A2-s1, d0
Switzerland	VKF	RF 1
France	-	M0
UK	BS 476 Part 6 & 7, BS 8414-1, BS 8414-2	BR 135
Russia	GOST 30244-94 method II, SNIP 21-01-97, TsNIISK Natural Fire Test	Class G1 "Flame retardant materials, which do not burn without a fire source"
USA	NFPA 285 (ISMA Test)	Passed

## ALPOLIC™ /fr

Country	Examination according to ...	Result & Classification
EU (applicable in Europe, Switzerland and Turkey)	EN 13823, EN ISO 11925-2, EN 13501-1	Class B-s1, d0
Germany	DIN 4102-1	B1
Switzerland	VKF	RF 2
France	-	M1
UK	BS 476 Part 6 & 7, BS 8414-1, BS 8414-2	BR 135
Poland	PN/B-02867	-
Czech Republic	CSN 73 0862, CSN 73 0863	Class C1
Hungary	MSZ 14800-6:2009	Passed
Austria	ONENORM B 3800-5	Passed
Russia	GOST 30244-94 method II, SNIP 21-01-97, TsNIISK Natural Fire Test	Class G1 "Hardly Inflammable Materials"
USA	NFPA 259-93 (British Thermal Unit)	Passed
	ASTM D1781-76 (Climbing Drum Peel Test)	Passed
	ASTM E-84 (Steiner Tunnel Test)	Class A/Class 1
	ASTM E-108 Modified	Passed
	UBC 26-9 & NFPA 285 (ISMA Test)	Passed
	ASTM E108 (Fire Test for Roof Covering)	Class A
	ASTM E119 (1 hr and 2 hrs Fire Rating)	Passed
	UBC 26-3 (Interior Room Corner Test)	Passed
Burn Toxicity Test New York State Uniform Fire Prevention and Building Code	Passed	

## SOME RECOMMENDATIONS BEFORE CHOOSING THE FAÇADE MATERIALS FOR YOUR PROJECT:

**1. For all types of materials**

Always request the complete Euroclass certificates and ask for the scope of application. Then check the following points:

- Is the substructure (wood or metal) and the fixing system part of the scope of application?
- Does the specification of the insulation material meet the project requirements? Regarding the nature of material (PIR, stone wool, glass wool, etc.), fire classification, thickness and density.
- Does the joint between the panels meet the project requirements?
- Does the rear ventilation space between the insulation and rear of the panel comply with the project requirements?
- Does the thickness of the paint system comply with the project requirements?

**2. For BS8414 test results**

Always request the full classification report in accordance with BR135 of the cladding product used, as it gives important information about its field of application and also the duration of the test. Some test reports state a test duration of 10 minutes but do not communicate what happens after that: fire spread and debris. The system must be tested for the full duration (exposure 15 minutes/observation 30 minutes) and meet the requirements.

**3. About Aluminium composite material (ACM)**

It is important to know that the aluminium composite material (ACM) is the only cladding panel that is regularly tested for its fire load (PCS value) through certifications, audits and external monitoring. The goal is to be sure that the composite material installed on your project has a stable and correct fire load. Is the core produced by the manufacturers themselves or is it prefabricated externally?

**Fire performance of the façade includes not only the panel but the complete system including the insulation.**

**Evaluation of the different fire loads on well-known fire accidents**

**The Grenfell Tower Block, London, 2017:** The building was covered with an ACM PE cladding in combination with PIR foam, adding the PCS values of the 2 materials, we get a huge total of  $123 + 216 = 339 \text{ MJ/m}^2$ .

**The Adoma Residential Building for immigrants, Dijon/France, 2010:** The wall cladding was ETICS/EWI based on polystyrene foam. Fire load value of more than  $111 \text{ MJ/m}^2$ .

**A student hall of residence, Bolton/USA, 2019:** This building was covered with HPL cladding made of PIR foam achieved the enormous PCS value of  $256 + 216 = 472 \text{ MJ/m}^2$ .

When ALPOLIC™ NC/A1 is used in combination with stone wool insulation, the system results in a fire load of  $15 \text{ MJ/m}^2$  ( $8 \text{ MJ/m}^2$  for the panel and  $7 \text{ MJ/m}^2$  for the stone wool insulation). This configuration contributes to fire performance with a reduced level of debris.

BE.SAFE: Use ALPOLIC™ on your project!

## ALPOLIC™ international:

### MITSUBISHI CHEMICAL INFRATEC CO., LTD.

ALPOLIC Business Unit  
1-1-1, Marunouchi, Chiyoda-ku, Tokio 100-8251, Japan  
phone: +81 3 6748-7348 | info@alpolic.jp

### MITSUBISHI CHEMICAL SINGAPORE PTE LTD.

ALPOLIC Division  
9 Raffles Place, #13-02 Republic Plaza, Singapore 048619  
phone: +65 6226-1597 | info@alpolic.sg

### MITSUBISHI CHEMICAL AMERICA, INC.

ALPOLIC Division  
401 Volvo Parkway, Chesapeake, VA 23320, USA  
phone USA: 800 422 7270 | phone international: +1 757 382 5750  
fax: +1 757 436 1896 | info@alpolic.com

# READY FOR FIRE-SAFE AND FUTURE-PROOF FAÇADES?

**Contact us!**  
**We will be happy to advise you –**  
**including face-to-face!**



## SUPPORTED EXCLUSIVELY in the UK & IRELAND by PCS Ltd (Pro Composite Solutions)

### 15+ Years of Industry Excellence Specialist Aluminium Solutions Provider

- Technical Consultation
- Product Training and CPD's
- Full Project Support
- Machining Applications Support

### For more information contact

### Your ALPOLIC™ Specialists:

Tel: +44 (0)3301 75 75 07  
Email: info@procompositesolutions.com  
50 Cowick Street, Exeter,  
EX4 1AP, England  
[www.procompositesolutions.com](http://www.procompositesolutions.com)

\*Terms and conditions apply. Contact PCS Ltd for full warranty details.

## ALPOLIC™ – the world's first address for aluminium composite panels



**Recycling**  
Our materials are almost  
100% recyclable. Even  
waste from ALPOLIC™  
plants is collected and  
recycled.

### Certifications



**ALPOLIC™** | MITSUBISHI POLYESTER FILM GmbH  
Kasteler Straße 45/E512 | 65203 Wiesbaden, Germany  
phone: +49 611 94077-9418 | fax: +49 611 962-9059 | info-alpolic@mcgc.com | www.alpolic.eu/en

